

eIC51FM

CEILING LOUDSPEAKERS

Fast-mounting In-ceiling Loudspeaker



PRODUCT OVERVIEW

eC51FM is a cost-effective in-ceiling installation loudspeaker with a great sound performance and a fast-mounting system without using tools or additional fixation systems. It features a 4.5" woofer and 70/100V line transformer with 3 and 6 W power options.

KEY FEATURES

- Easy and fast mounting
- One-way, full range
- 4.5" woofer
- 6WRMS
- Power options 100V: 3 / 6W
- Power options 70V: 1,5 / 3W
- Max SPL (Peak) :105dB
- Effective frequency range (-10dB): 115 Hz - 17 kHz
- Coverage angle: 157°
- Screw terminals
- Material: ABS plastic basket, powder coated iron grille
- Available in white colour (RAL 9016)
- EASE and EASE Address file available

APPLICATIONS

- Commercial
- Corporate
- Sports and wellness
- Leisure

TECHNICAL SPECIFICATIONS

eIC51FM

System	
Effective frequency range ¹	115 Hz - 17 kHz (-10dB)
Coverage angle ²	157°x157° (HxV)
Power handling	6W RMS / 24W Peak
Sensitivity ³	91dB (1W/1m)
Maximum SPL ⁴	99dB continuous / 105dB peak
Power options	100V: 3 / 6 W 70V: 1,5 / 3 W
Recommended amplifier	12W
Transducers	
Ways	1-way, full range
Driver	4.5" woofer, ferrite magnet and paper cone
Nominal impedance	8Ω
Physical	
Connection type	Screw terminals
Power type selector	Color code connection (rear panel)
Installation options	In-ceiling, in-wall
Environmental	IP50 rated
Enclosure material	ABS plastic
Grille material	Powder coated iron
Mounting system	Spring clamps
Finished color	White (RAL 9016)
External diameter	160mm / 6.3"
Recommended cut out diameter	145mm / 5.7"
Required depth	>54mm / 2.1"
Ceiling thickness	No limit min 55mm / 2.17" max
Weight	0,5 kg. / 1.1 lb.
Pieces per box	1 unit
Shipping dimensions	178 x 178 x 63mm / 7.0" x 7.0" x 2.5" (WxHxD)
Shipping weight	0,75 kg. / 1.7 lb.

¹10dB below the sound pressure level at specified sensitivity

²6dB below the sound pressure level than that at the direction of maximum level, Max. angle between 1 kHz and 4 kHz.

³Measured on-axis, far field and referenced to 1 meter by inverse square law. Average from 100 Hz to 10 kHz.

⁴Calculated from sensitivity and power handling specifications, exclusive of power compression

FREQUENCY RESPONSE ON-AXIS

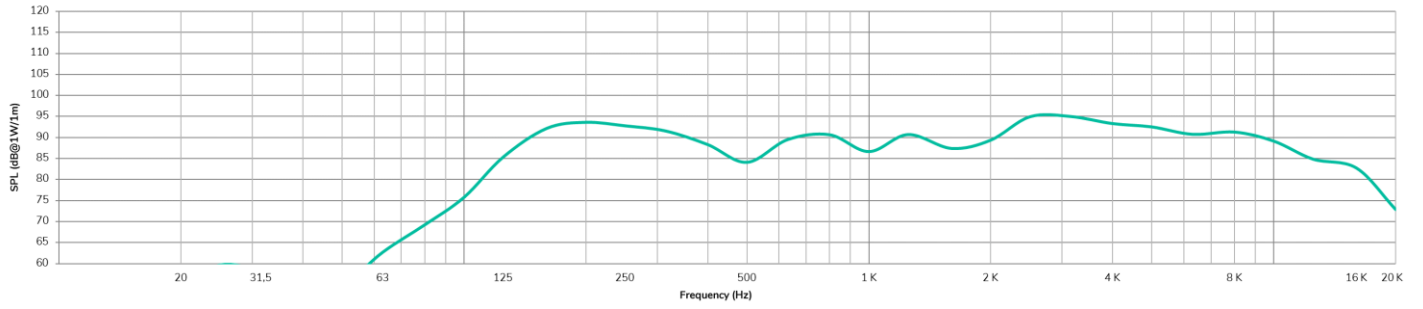

POLAR DIAGRAMS

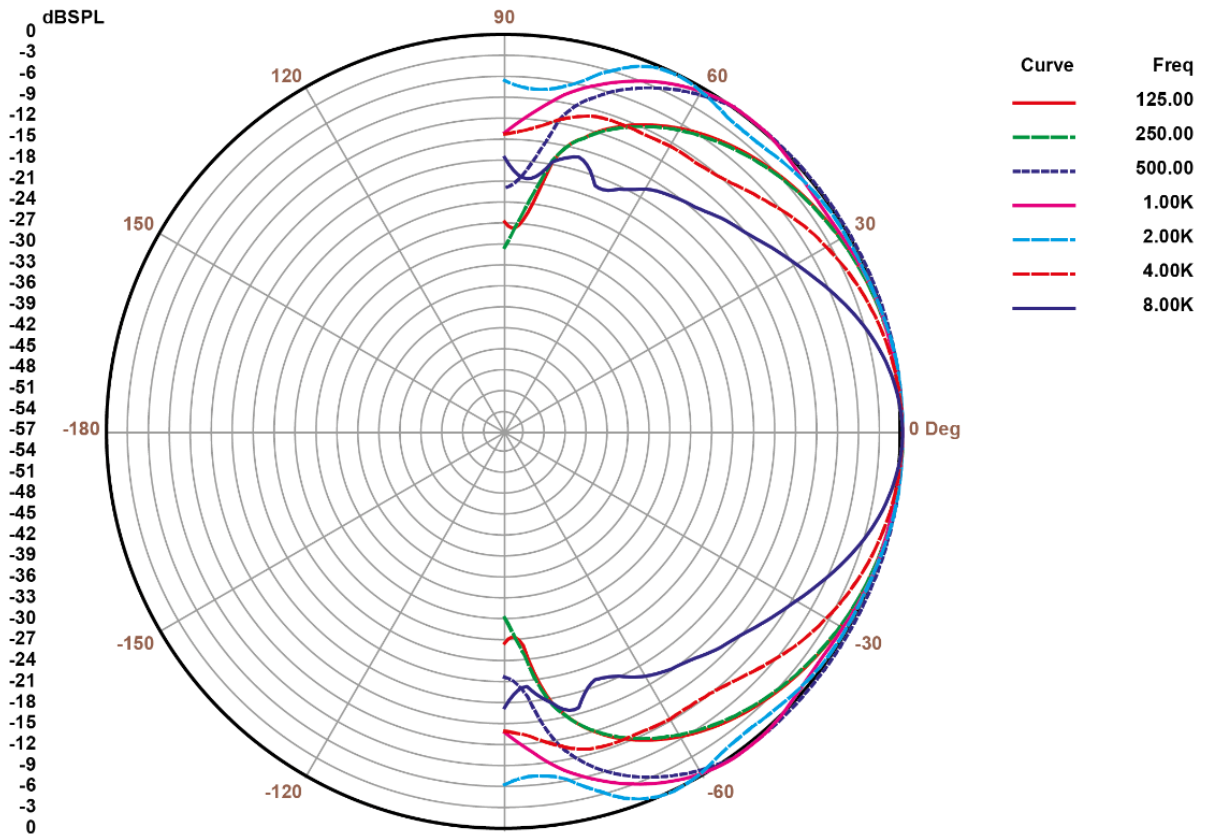

MECHANICAL DIAGRAMS

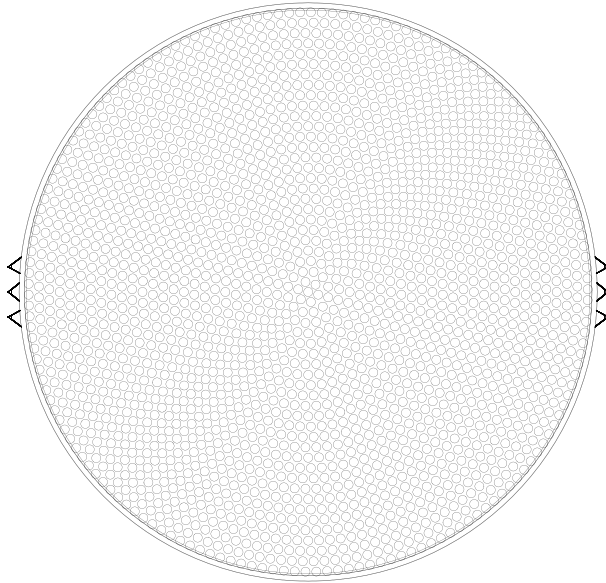

FRONT

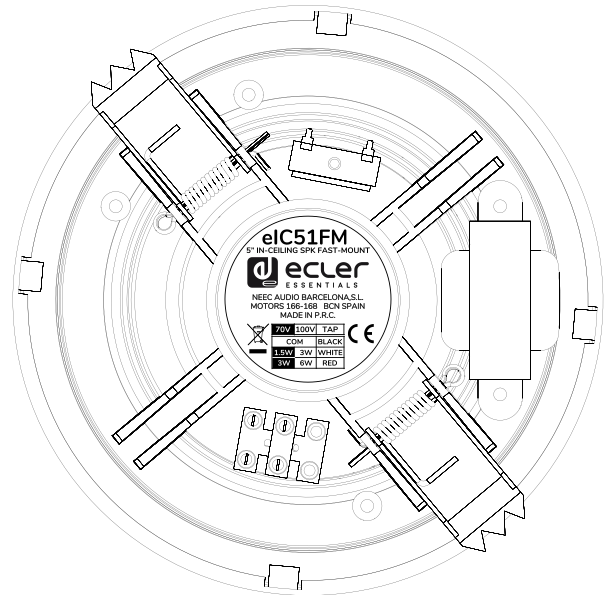

REAR

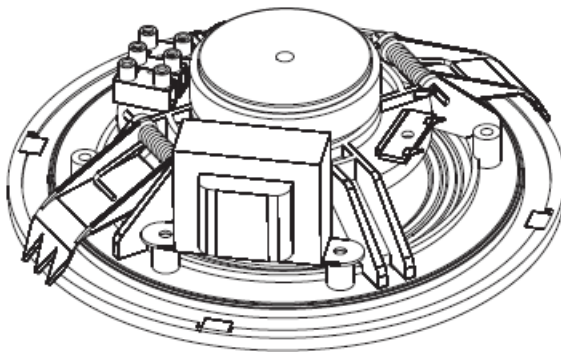

PERSPECTIVE

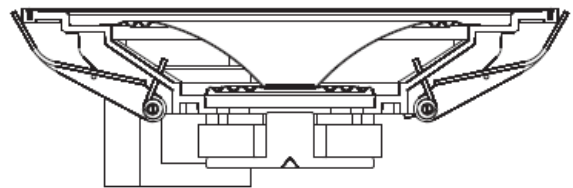

SIDE

Distances are in millimeters

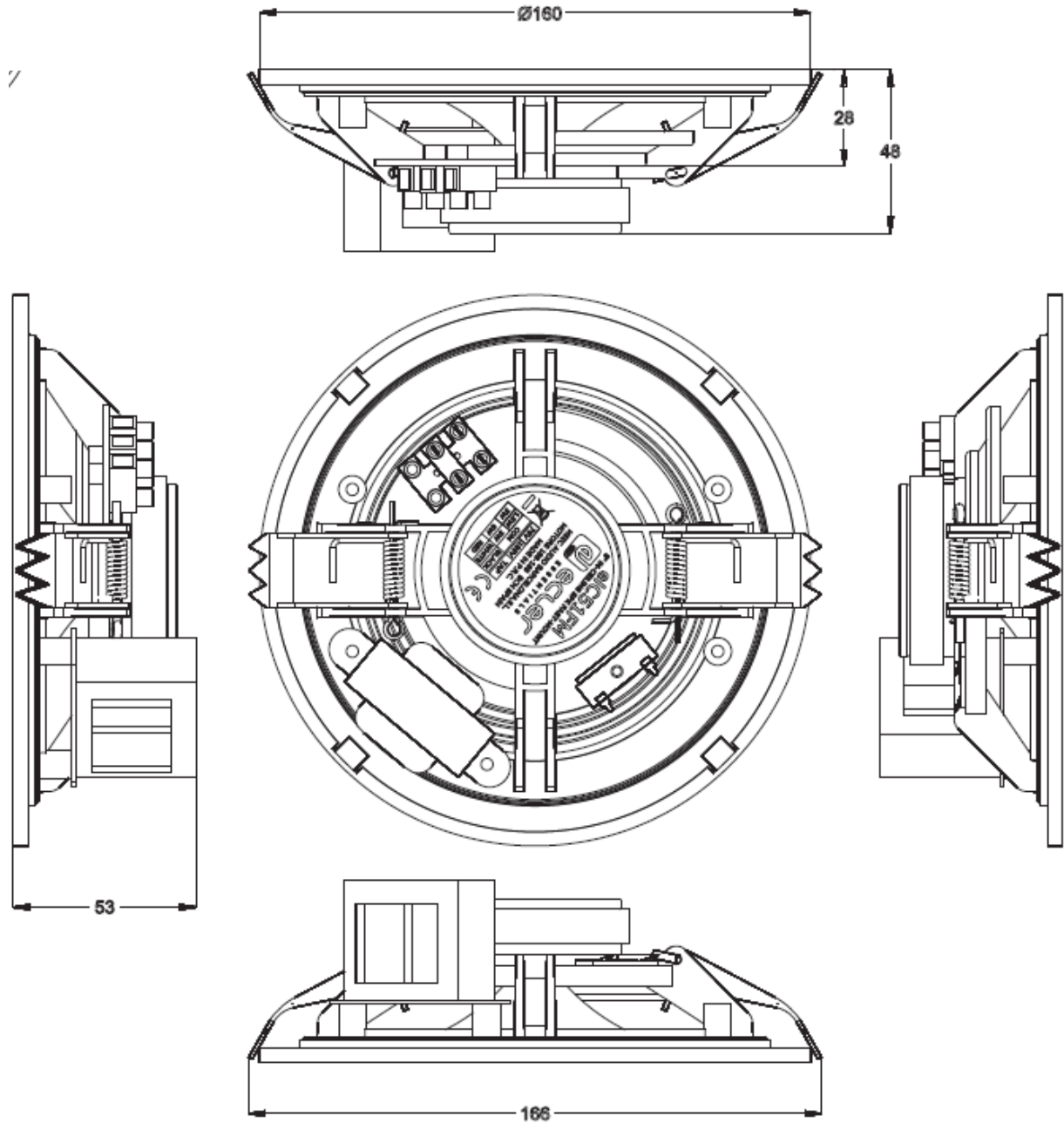

A&E SPECIFICATIONS

The in-ceiling installation loudspeaker shall be a 4.5" woofer suitable for 70/100 V line or low impedance installations. The power handling should be 6 W RMS at a rated impedance of 8 Ω with a peak power handling of 24 W. It shall include a line transformer with options for 6 and 3 W in 100V line and 3 and 1'5 W in 70V line, including an 8 Ω connection.

The effective frequency range shall be from 115 Hz to 17 kHz. The sensitivity shall be 91 dB, and the peak continuous sound pressure level shall be 105dB. The covered angle shall be 157°.

The enclosure shall be made of ABS plastic and the borderless grill shall be made of powder coated iron. It shall come available in white (RAL9016) colour. Mounting of the speaker into the ceiling shall be possible using spring clamps, for a fast installation. Connection to the amplifier shall be made via screw terminals. It should be ready for indoor installation, IP50 rated.

The loudspeaker shall have an external diameter of 160 mm, the required depth for installation shall be major than 54 mm and the weight shall not exceed 0'5 kg. The cut-out diameter shall be 145 mm. It shall be available data files that can be used with EASE and EASE ADDRESS acoustic simulation software.

The loudspeaker shall be the ECLER eIC51FM.

All product characteristics are subject to variation due to production tolerances. **NEEC AUDIO BARCELONA S.L.** reserves the right to make changes or improvements in the design or manufacturing that may affect these product specifications

For technical queries contact your supplier, distributor or complete the contact form on our website, in [Support / Technical requests](#).

Motors, 166-168 - 08038 Barcelona - Spain - (+34) 932238403 | information@ecler.com | www.ecler.com